Connecting the Explorer[®] 8240[™] Digital Video Recorder



Notice for CATV Installers

CATV Installers Notice

If you are a CATV installer, read the information in the box below.

<p>Note to CATV System Installer (U.S.A. and Canada Only)</p> <p>This reminder is provided to call the CATV system installer's attention to Article 820-40 of the NEC (Section 54, Part I of the Canadian Electrical Code), that provides guidelines for proper grounding and, in particular, specifies that the CATV cable ground shall be connected to the grounding system of the building, as close to the point of cable entry as practical.</p> <div data-bbox="597 688 732 810"></div> <p>This symbol is intended to alert you that uninsulated voltage within this product may have sufficient magnitude to cause electric shock. Therefore, it is dangerous to make any kind of contact with any inside part of this product.</p>	<table border="1"><tr><td data-bbox="943 365 1029 443"></td><td data-bbox="1052 317 1263 499"><p>CAUTION RISK OF ELECTRIC SHOCK DO NOT OPEN</p><p>AVIS RISQUE DE CHOC ÉLECTRIQUE NE PAS OUVRIR</p></td><td data-bbox="1279 365 1365 443"></td></tr></table> <p>CAUTION: To reduce the risk of electric shock, do not remove cover (or back). No user-serviceable parts inside. Refer servicing to qualified service personnel.</p> <p>WARNING TO PREVENT FIRE OR ELECTRIC SHOCK, DO NOT EXPOSE THIS UNIT TO RAIN OR MOISTURE.</p> <div data-bbox="1084 716 1219 837"></div> <p>This symbol is intended to alert you of the presence of important operating and maintenance (servicing) instructions in the literature accompanying this product.</p>		<p>CAUTION RISK OF ELECTRIC SHOCK DO NOT OPEN</p> <p>AVIS RISQUE DE CHOC ÉLECTRIQUE NE PAS OUVRIR</p>	
	<p>CAUTION RISK OF ELECTRIC SHOCK DO NOT OPEN</p> <p>AVIS RISQUE DE CHOC ÉLECTRIQUE NE PAS OUVRIR</p>			

U.S. Patents

U.S. Patents List

A patent notice is affixed to this product. In addition, the product may also be covered by one or more of the following patents:

4,636,852; 4,641,181; 4,651,208; 4,691,353; 4,698,598; 4,719,642; 4,748,667; 4,829,569; 4,866,770; 4,885,775; 4,888,799; 4,890,319; 4,922,532; 4,965,534; 5,012,510; 5,029,207; 5,045,816; 5,053,883; 5,058,160; 5,142,690; 5,146,526; 5,214,390; 5,225,902; 5,225,925; 5,237,610; 5,239,540; 5,241,610; 5,255,086; 5,257,403; 5,267,071; 5,270,809; 5,271,041; 5,272,752; 5,282,028; 5,285,497; 5,287,351; 5,309,514; 5,319,709; 5,341,425; 5,347,388; 5,347,389; 5,361,156; 5,367,571; 5,379,141; 5,379,145; 5,381,481; 5,390,337; 5,400,401; 5,406,558; 5,418,782; 5,428,404; 5,430,568; 5,434,610; 5,436,749; 5,442,472; 5,455,570; 5,471,492; 5,477,199; 5,477,370; 5,481,389; 5,485,221; 5,493,339; 5,500,758; 5,502,499; 5,506,904; 5,519,780; 5,550,825; 5,579,055; 5,579,057; 5,583,562; 5,596,606; 5,600,378; 5,602,933; 5,640,388; 5,657,414; 5,675,575; 5,715,515; 5,724,525; 5,740,300; 5,742,677; 5,754,940; 5,757,416; 5,771,064; 5,774,859; 5,825,829; 5,826,167; 5,850,305; 5,854,703; 5,870,474; 5,892,607; 5,920,626; 5,923,755; 5,930,024; 5,930,515; 5,937,067; 5,963,352; 5,966,163; 5,982,424; 5,991,139; 5,999,207; 6,005,631; 6,005,938; 6,016,163; 6,028,941; 6,029,046; 6,052,384; 6,055,244; 6,072,532; 6,105,134; 6,148,039; 6,157,719; 6,188,729; 6,195,389; 6,212,278; 6,215,530; 6,219,358; 6,240,103; 6,243,145; 6,246,767; 6,252,964; 6,272,226; 6,292,081; 6,292,568; 6,320,131; 6,374,275; 6,405,239; 6,411,602; 6,417,949; 6,424,714; 6,424,717; 6,433,906; 6,438,139; 6,463,586; 6,467,091; 6,476,878; 6,493,876; 6,510,519; 6,516,002; 6,516,412; 6,526,508; 6,538,595; 6,546,013; 6,560,340; 6,567,118; 6,570,888; 6,622,308; 6,629,227; 6,664,984; 6,667,994; 6,671,879; 6,674,967; 6,678,891; 6,714,598; 6,721,352; 6,721,956; 6,725,459; 6,738,982; 6,744,892; 6,744,967; 6,751,271; 6,760,918; 6,795,972; 6,802,077; 6,804,708; 6,811,447; 6,817,028; D348065; D354959; D359737; D363932; D390217; D434753; RE36988

Contents

Important Safety Instructions	4
Change the Way You Watch TV	6
Safety First	6
The Explorer eClub	6
Identify Your 8240 DVR.....	6
What's On the Front Panel?	7
What's On the Back Panel?	8
Connecting the 8240 DVR	9
Connections for a Standard-Definition TV and VCR	10
Watch TV	11
Access Services and Programs	11
Record One Program While Watching Another	11
Watch Two Programs at the Same Time	11
Avoid Screen Burn-In!	11
Performance Tips	12
No Picture	12
No Color	12
No Sound.....	12
Automatic Software Updates	12
Frequently Asked Questions	12
Where Are the Connection Diagrams:.....	12
What Cables Do I Need?	12
Connecting the 8240 DVR to a Standard TV and Standard VCR	13
Connecting the 8240 DVR to a Stereo TV and Stereo VCR	14
Connecting the 8240 DVR to a Home Theater Receiver and Stereo TV	15
Connecting the 8240 DVR to an External SATA Hard Disk Drive (optional)	16
Compliance Information	18

IMPORTANT SAFETY INSTRUCTIONS

Heed Warnings

Adhere to all warnings on the product and in the operating instructions.

Read, Retain, and Follow These Instructions

Read all of the instructions before you operate this product. Follow all operating instructions that accompany this product. Retain the instructions for future use. Give particular attention to all safety precautions.

Comply With Warnings

Avoid electric shock. Comply with all warnings and cautions in the operating instructions, as well as those that are affixed to this product.

Power Warnings

Providing a Power Source

A label on this product indicates the correct power source for this product. Operate this product only from an electrical outlet with the voltage and frequency indicated on the product label.

If you are uncertain of the type of power supply to your home or business, consult your cable service provider or your local power company.

Grounding This Product (USA/Canada Only)



WARNING: To avoid electric shock and fire hazard, match the plug and outlet connections carefully, then fully insert. If the plug and outlet do not match, or you cannot fully insert the plug, contact an electrician to update your power outlets.

If this product is equipped with either a three-prong (grounding pin) safety plug or a two-prong (polarized) safety plug, follow these safety guidelines to properly ground this product.

- For a 3-prong plug (one prong on this plug is a protective grounding pin), insert the plug into a grounded mains, 3-prong outlet.

Note: This plug fits only one way. If you are unable to insert this plug fully into the outlet, contact your electrician to replace your obsolete outlet.

- For a 2-prong plug (a polarized plug with one wide blade and one narrow blade), insert the plug into a polarized mains, 2-prong outlet in which one socket is wider than the other.

Note: If you are unable to insert this plug fully into the outlet, try reversing the plug. If the plug still fails to fit, contact an electrician to replace your obsolete outlet.

Overloading



WARNING: Avoid electric shock and fire hazard! Do not overload mains AC outlets and extension cords. For products that require battery power or other power sources to operate them, refer to the operating instructions for those products.

Do not overload electrical outlets, extension cords, or integral convenience receptacles as this can result in a risk of fire or electric shock. For products that require battery power or other sources to operate, refer to the operating instructions for that product.

Preventing Power Cord Damage

Arrange all power cords so that people or pets cannot walk on the cords. Do not place objects on the cords. Do not lean objects against the cords. Placing objects on or leaning objects against cords can damage the cords. Give particular attention to cords at the point at which the cord connects to plugs, at the electrical outlets, and where the cords exit the product.

Usage Warnings

Providing Ventilation

This product has openings for ventilation that protect it from overheating. To ensure the reliability of this product, do the following:

- Do not block or cover these openings.
- Do not place entertainment devices (such as VCRs or DVDs), lamps, books, vases with liquids, or other objects on top of this product.
- Do not place this product in any of the following locations:
 - On a bed, sofa, rug, or similar surface
 - Near heat sources such as radiators, heat registers, stoves, or other products (including amplifiers) that produce heat
 - In an enclosure, such as a bookcase or rack, unless the installation provides proper ventilation

Selecting a Proper Location



WARNING: Avoid personal injury and damage to this product! An unstable surface may cause this product to fall.

Place this product in a location that is close enough to an electrical outlet and where the power cord is easily accessible to be disconnected from the wall outlet or from the rear panel of the product.

Important: The power cord is the mains power supply disconnect device.

Place this product on a stable surface. The surface must support the size and weight of this product.

Cleaning This Product



WARNING: Avoid electric shock! Unplug this product before cleaning.

Before cleaning this product, unplug it from the electrical outlet. Use a damp cloth to clean this product. Do not use a liquid cleaner or an aerosol cleaner. Do not use a magnetic/static cleaning device (dust remover) to clean this product.

IMPORTANT SAFETY INSTRUCTIONS, continued

Protecting This Product From Foreign Objects and Water or Moisture Damage



WARNING: Avoid electric shock and fire hazard! Never push objects through the openings in this product. Foreign objects can cause electrical shorts that can result in electric shock or fire. Do not expose this product to rain or moisture. Do not place objects filled with liquid, such as vases, on this product.

Never push objects of any kind into this product through openings as they may touch dangerous voltage points or short out parts that could result in a fire or electric shock.

Do not expose this product to liquids or moisture. Do not place this product on a wet surface. Do not spill liquids on or near this product.

Do not use this product near water (such as a bath tub, wash bowl, sink, or laundry tub), in a wet basement, or near a swimming pool.

Accessories Warnings



WARNING: Avoid any potential for electric shock or fire. Do not use accessories with this product unless recommended by your cable service provider.

Avoid any potential for electric shock or fire.

Do not use accessories with this product unless recommended by your cable service provider.

Service Warnings

Servicing This Product



WARNING: Avoid electric shock! Opening or removing the cover may expose you to dangerous voltages. This product contains no user-serviceable parts. Refer all servicing to qualified service personnel.

Do not open the cover of this product. If you open the cover, your warranty will be void. Refer all servicing to qualified personnel only. Contact your cable service provider for instructions.

Obtaining Service for Product Damage

For damage that requires service, unplug this product from the AC outlet. Then, contact your cable service provider or qualified service personnel to obtain service for the following conditions:

- If there is damage to the power-supply cord or plug
- If liquid enters this product
- If you expose this product to rain or water
- If you drop this product, a heavy object falls on this product, or damage occurs to the cover of this product
- If this product does not operate normally by following the operating instructions
- If this product exhibits a distinct change in performance

Checking Product Safety

Upon completion of any service or repairs to this product, the service technician must perform safety checks to determine that this product is in proper operating condition.

Outdoor Grounding System

If this product connects to an outdoor antenna or cable system, be sure the antenna or cable system is grounded (earthed). This provides some protection against voltage surges and built-up static charges.

Article 810 of the National Electric Code (NEC) ANSI/NFPA No. 70-1990, provides the following information:

- Grounding of the mast and supporting structure
- Grounding the lead-in wire to an antenna discharge unit
- Size of the grounding conductors
- Location of the antenna-discharge unit
- Connection to grounding electrodes
- Requirements for the grounding electrodes (see the following antenna grounding diagram as recommended by NEC ANSI/NFPA 70)

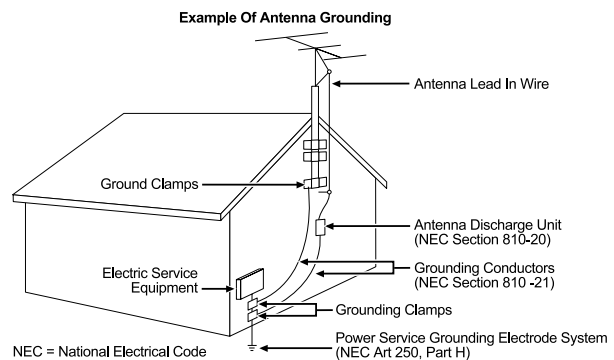

Lightning

For added protection for this product during a lightning storm, or when it is left unattended and unused for long periods of time, unplug it from the wall outlet and disconnect the antenna or cable system. This will prevent damage to the product due to lightning and power-line surges. Plugging this product into a surge protector in order to reduce the risk of damage.

Note: Unplugging this product for an extended period of time can result in loss of authorization. For reauthorization, contact your cable service provider.

Power Lines



WARNING: To avoid electric shock, do not locate an outside antenna system in the vicinity of overhead power lines or power circuits.

Do not locate an outside antenna system in the vicinity of overhead power lines or power circuits. When installing an outside antenna system, take extreme care to keep from touching power lines or circuits, as contact might be fatal.

Change the Way You Watch TV

DVR makes it easy to watch TV on your terms. The Explorer® 8240™ Digital Video Recorder (DVR) is the simple way to take control over your TV – and your life. You take control because DVR lets you decide what’s on TV and when. So there’s no more putting off the things you need to do, just because there’s a show on TV you want to watch. Just think what DVR can do for you:

- Never miss a minute of your favorite movie or the big game. Simply pause the live action and play again when you’re ready. You can even rewind what you missed.
- Two of your favorite shows on at the exact same time? Simple. Just record one program while you watch the other. You can even record two programs at the same time while watching a previously recorded program. Your VCR can’t do that.
- Is your favorite sports team having an away game and you can’t go. Imagine being able to record it and watch it at a more convenient time.

Don’t miss another minute of the TV shows you love!

Follow the instructions in this guide to install the 8240 DVR, to become familiar with the buttons on the front panel, and to access your cable services. Then, enjoy the features of the 8240 DVR and change the way you watch TV!

Safety First

Before using the 8240 DVR, read the Important Safety Instructions section of this guide.

The Explorer eClub

The online Explorer eClub provides news and information about the Explorer 8240 DVR. You can access the Explorer eClub on the Internet at the following Web address:

www.scientificatlanta.com/explorerclub

To join and access the online Explorer eClub, you must enter the model number of your 8240 DVR. The model number is located on the front panel.

Identify Your 8240 DVR

If the 8240 DVR requires troubleshooting in the future, your cable service provider may ask for the serial number.

To find the serial number for your 8240 DVR, look on the back panel for a label that is similar to the example shown here. The serial number begins with “SA” and is located in the lower left corner of the bar code.

Use the space provided here to record the serial number:

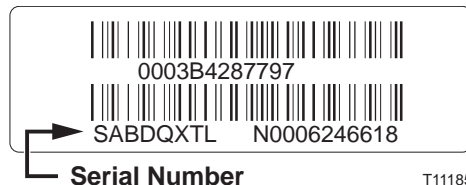

What's On the Front Panel?

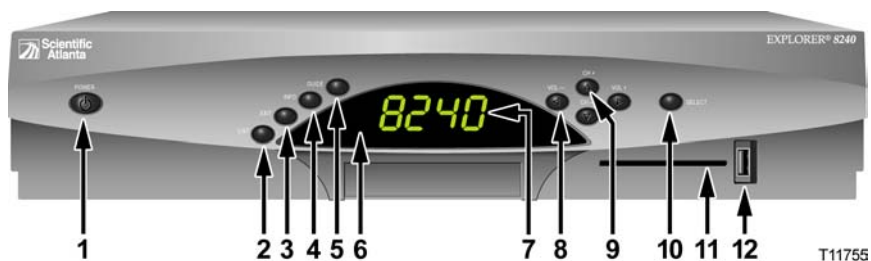

- | | |
|--------------------------|--|
| 1 Power | Turns the 8240 DVR on and off |
| 2 List | Displays the list of recorded programs |
| 3 Exit | Exits menus, the on-screen guide, and program information |
| 4 Info | Displays a description of the selected program. This button is available from the on-screen guide and while viewing a program |
| 5 Guide | Accesses on-screen services, such as the on-screen guide, video-on-demand, or pay-per-view |
| 6 IR Sensor | Receives the infrared signal from the remote control |
| 7 LED Display | Displays the selected channel number and time of day. The LED also displays the following: <ul style="list-style-type: none"> • Message (≡✉) • Power (⏻) • RECORD |
| 8 VOL + and VOL - | Enables you to increase and decrease the volume |
| 9 CH + and CH - | Enables you to scroll up and down through the channels |
| 10 Select | Provides access to your on-screen choices |
| 11 Smart Card* | Allows smart card access |
| 12 USB Port* | Connects to external equipment, such as a keyboard |

* These connectors are reserved for future use or may not be available on all 8240 DVR models.

What's On the Back Panel?

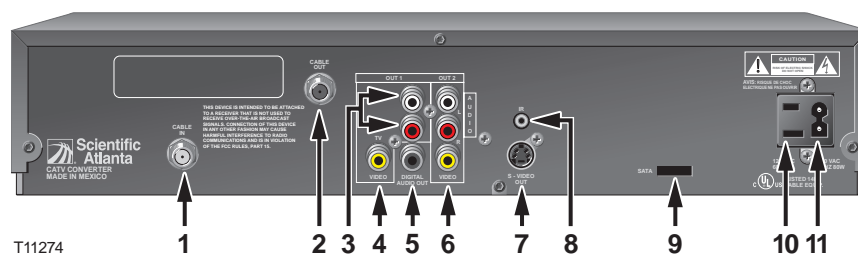

- T11274
- 1 Cable In** Connect the coaxial cable that delivers the signal from your cable service provider.
 - 2 Cable Out** Connect a coaxial cable to Cable Out to send audio and video signals to a TV or VCR. These signals are standard-definition TV (SDTV) video and stereo audio.
 - 3 Audio Out (LEFT and RIGHT)** Connect RCA cables to Audio Out to send audio signals (left and right) to a TV with stereo outputs.
 - 4 Video Out** Connect to video input of TV or VCR.
 - 5 Digital Audio Out** Connect an RCA cable to send a digital audio signal to a surround-sound receiver or other digital audio device.
 - 6 Secondary Video and Audio Out** Connect to either a VCR for archiving saved content from the 8240 DVR or connect to another set of inputs (composite) on your TV.
 - 7 S-Video Out (LEFT and RIGHT)** Connect an S-Video cable to send an S-Video signal to your TV or VCR. This signal is standard definition but higher quality than other SDTV connections.
 - 8 IR** (This connector reserved for future use.)
 - 9 SATA** Connect to an external Serial ATA (SATA) hard disk drive for expanded recording capacity. Check with your cable service provider for a list of approved hard drive models for use with the 8240 DVR.
 - 10 AC Outlet** Connect the AC power cord from another device, such as a TV.
 - 11 AC Power Input** Connect the power cord to deliver power to the 8240 DVR.

Connecting the 8240 DVR

To connect your 8240 DVR to your entertainment devices, complete these steps.

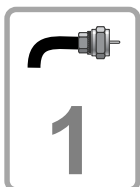

Connect the coaxial cable that carries the signal from your cable service provider to the CABLE IN connector on the back panel of the set-top.

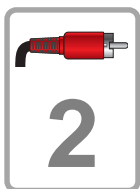

Connect your SDTV to the 8240 DVR. Refer to the **Connections for a Standard-Definition TV and Standard VCR** section on page 13.



Identify the additional devices you will connect to the 8240 DVR and TV. See pages 13 through 16 and the related user's guides for more information.

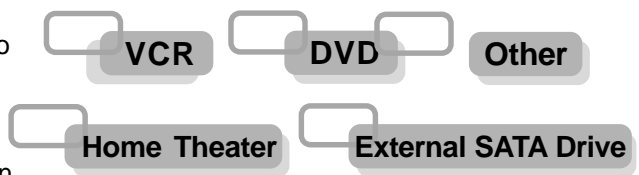

Plug the 8240 DVR and the TV into an AC power source.

Important: To protect the set-top from power surge damage, ground (earth) your cable product to provide some protection against voltage surges and built-up static charges. To avoid these voltage surges that can be caused by lightning storms and power outages, plug the set-top into a surge protector to reduce the risk of damage.



Do not turn on the 8240 DVR or TV yet.



It may take several minutes for the 8240 DVR to receive the latest software, programming, and service information. Wait until you see one of the following displays on the front panel of the 8240 DVR that indicates that the update is complete:

- Current time
- Four dashes (- - - -)

Note: If four dashes are displayed, your 8240 DVR is not authorized. Call your cable service provider.

























To begin watching TV, turn the TV ON, and press POWER on the front panel of the 8240 DVR or Power on the remote control.

Connections for a Standard-Definition TV and VCR

When using the 8240 DVR with an SDTV, you must make one of the following connections to view content. Some SDTVs may not have all of these connections. In addition, you can make connections to a VCR to archive recordings to a VCR tape. Refer to your TV and VCR user's guide and the cabling diagrams in this guide for more information.

Note: The labeling on your 8240 DVR model may vary from the labels shown in the following table.

Required Connections to an SDTV (choose one)		8240 DVR Connections	SDTV Connections
Cable Out	The Cable Out connection provides both a video and an audio connection to an SDTV. See page 13 for an example.	 CABLE OUT	 CABLE/ANTENNA
Video	The Video Out connection provides video to a standard definition TV. The left and right audio outputs provide stereo sound. See page 14 for an example.	OUT 1  TV VIDEO  L  R	 L  R AUDIO 1 IN  VIDEO IN
S-Video	The S-Video out connection provides optimal video to a standard definition TV. The left and right audio outputs provide stereo sound.	OUT 1  L  R  S-VIDEO OUT	 S-VIDEO IN  L  R AUDIO 1 IN
Optional Connections		8240 DVR Connections	VCR Connections
VCR	The Cable Out connection provides both a video and an audio connection to the VCR. See page 13 for an example.	 CABLE OUT	 CABLE/ANTENNA
Stereo VCR	For VCRs that have Video and Left and Right audio connectors you can use the OUT 2 connectors (Video, Left, and Right) on the 8240 DVR. See page 14 for an example.	OUT 2  L  R  VIDEO AUDIO	 VIDEO IN  L  R AUDIO IN

Watch TV

Access Services and Programs

Access cable services and programs by pressing the following keys on the remote control:

- **Guide**—Access the on-screen guide. The on-screen guide displays schedules of TV programs and other services available from your cable service provider, such as video-on-demand and pay-per-view programs.
- **Arrows**—Select a program in the schedule.
- **Info**—Display a specific program description (either from the on-screen guide or while viewing a program).
- **Select**—View a specific program in the guide.

Record One Program While Watching Another

When two of your favorite programs are scheduled at the same time, you can record one program on the built-in DVR while watching the other. Use the DVR keys on the remote control to record programs or to play back recorded programs.



T10964

Watch Two Programs at the Same Time

You do not need a special TV to watch two programs at the same time. Use the picture-in-picture (PIP) keys on the remote control, and you will see a PIP screen on your TV.



T10965



WARNING:
Avoid screen burn-in!
Do not display the same fixed images on your TV screen for extended periods of time.

Avoid Screen Burn-In!

Images such as letterbox bars or side bars, bright closed-captioning backgrounds, station logos, or any other stationary images may cause the picture tube in your TV to age unevenly; this is known as screen burn-in. Refer to the user's guide that came with your TV for more information.

Performance Tips

If the 8240 DVR does not perform as expected, the following tips may help. If you need further assistance, contact your cable service provider.

No Picture

- Verify that the power to your TV is turned on.
- If the 8240 DVR is plugged into a wall switch, verify the wall switch is in the ON position.

Note: You should *avoid* plugging the 8240 DVR into an outlet that is controlled by a wall switch.

- Verify that all cables are properly connected.
- If your system includes a VCR or stereo, verify that you have properly connected them to the 8240 DVR.
- Verify that the TV is set to the proper input channel.
- The current channel may not be available in your service package. Try selecting another channel to see if video is available.

No Color

- Verify that the current TV program is broadcast in color.
- Adjust the TV color controls.

No Sound

- If your setup includes a stereo, verify that you have properly connected it to the 8240 DVR.
- Verify that the volume is turned up.
- Verify that the mute function is not engaged.
- The current channel may not be available in your service package. Try selecting another channel.

Automatic Software Updates

The TV screen may display a message that indicates the 8240 DVR is automatically updating its software. Should this occur, wait for the time to display on the front panel of your 8240 DVR before continuing. When the front panel displays the time, the update is complete.

Frequently Asked Questions

Where Are the Connection Diagrams?

The diagrams are on pages 13 through 16 of this guide. The diagrams show examples of common ways to connect the 8240 DVR to your TV, VCR, and home theater receiver. However, these diagrams do not show every possible combination of devices. Refer to the user's guides that came with your other electronic devices for further information.

What Cables Do I Need?

The required cables are shown in the connection diagrams in this guide. Some of the cables and adaptors shown in the diagrams may not be included with the 8240 DVR.

Connecting the 8240 DVR to a Standard TV

Explorer 8240

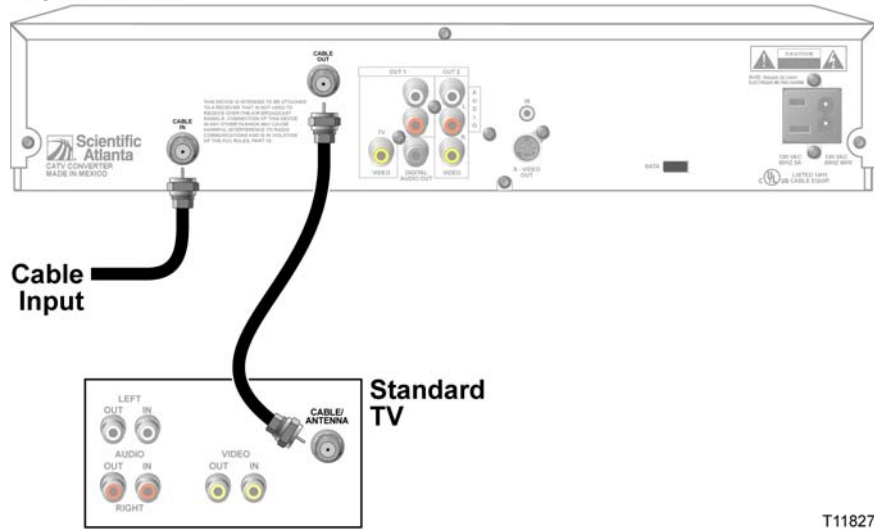

WARNING:
 Electric shock hazard!
 Unplug all electronic
 devices before
 connecting or
 disconnecting any
 device cables for the
 8240 DVR.

T11827

Connecting the 8240 DVR to a Standard TV and Standard VCR

Explorer 8240

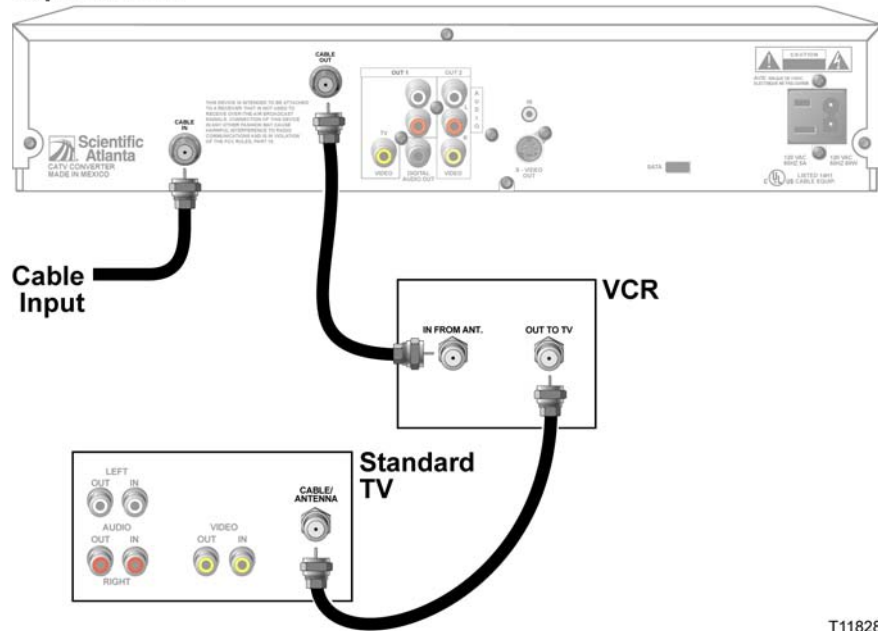

WARNING:
 Electric shock hazard!
 Unplug all electronic
 devices before
 connecting or
 disconnecting any
 device cables for the
 8240 DVR.

T11828

Connecting the 8240 DVR to a Stereo TV

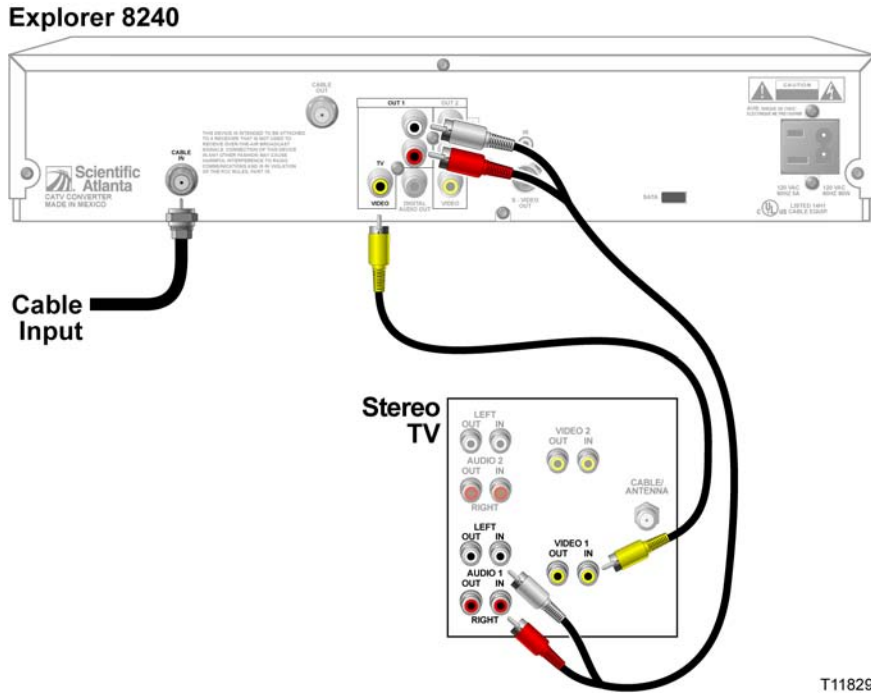

WARNING:
 Electric shock hazard!
 Unplug all electronic
 devices before
 connecting or
 disconnecting any
 device cables for the
 8240 DVR.

T11829

Connecting the 8240 DVR to a Stereo TV and Stereo VCR

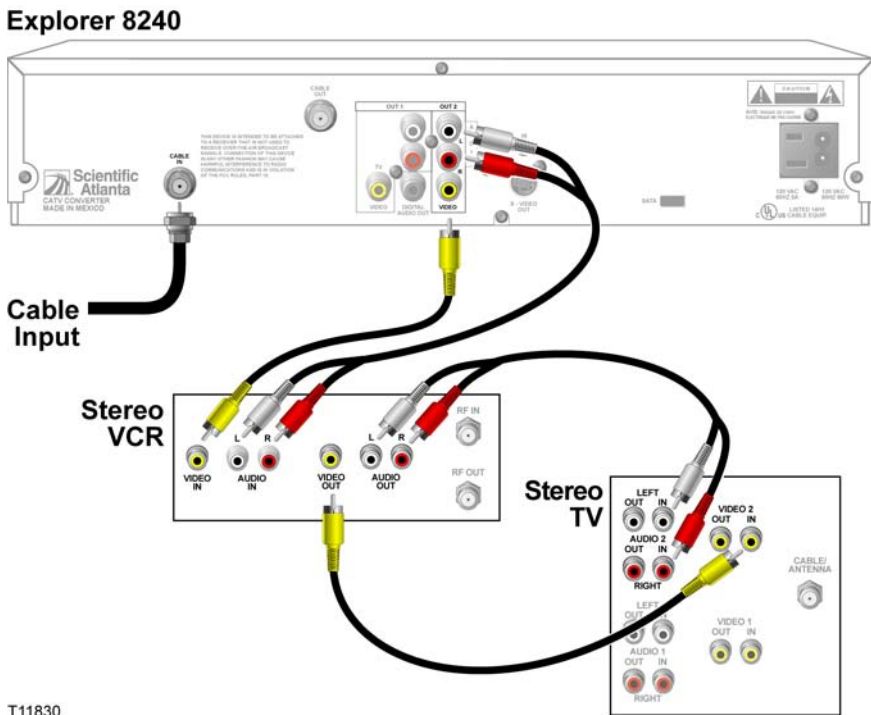

Note: This connection allows for archiving to the VCR and for watching VCR tapes on your TV. You may also choose to connect OUT 1 from the 8240 DVR directly to the TV, so that you may watch live channels on the TV during any archive-to-VCR process.

WARNING:
 Electric shock hazard!
 Unplug all electronic
 devices before
 connecting or
 disconnecting any
 device cables for the
 8240 DVR.

T11830

Connecting the 8240 DVR to a Home Theater Receiver and Stereo TV

Explorer 8240

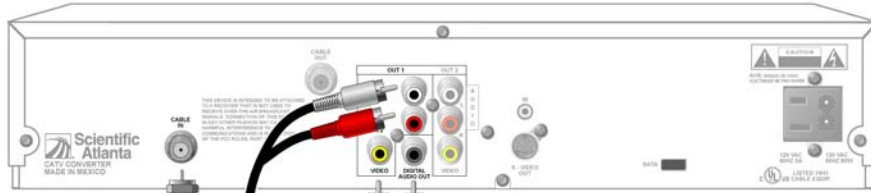

Cable Input

Home Theater Receiver

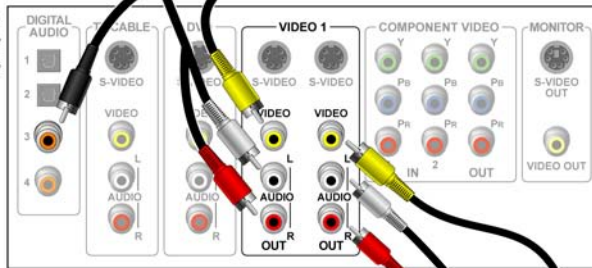

Stereo TV

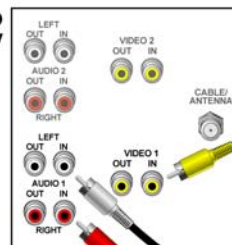

WARNING:
 Electric shock hazard!
 Unplug all electronic devices before connecting or disconnecting any device cables for the 8240 DVR.

T11831

Connecting the 8240 DVR to an External SATA Hard Disk Drive (optional)

Complete the following steps to install a SATA drive.

1. Make sure that both the 8240 DVR and the external SATA drive are unplugged from power.
2. Connect the data cable for the SATA drive to the 8240 DVR.
3. Plug in power to the external SATA drive.
4. Plug in the 8240 DVR power cord, and then turn on the 8240 DVR.
5. Follow the on-screen instructions. One of the following occurs:
 - If it is a new drive or one used on another device, you will be asked to format it.
 - If the drive is formatted and will work with this 8240 DVR, you will get a confirmation that the drive is working.

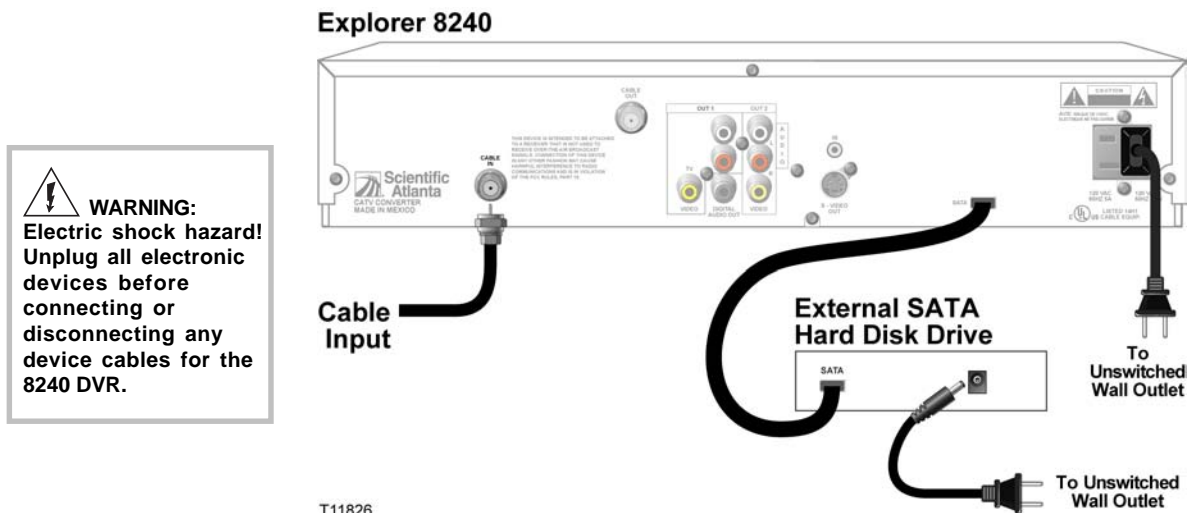

Guidelines for Using the External SATA Hard Disk Drive

The external SATA hard disk drive requires continuous power. If the SATA drive loses power while the 8240 DVR is plugged in, the 8240 DVR may stop current recordings or not provide enough space for future recordings. Follow these guidelines for using the SATA drive:

- Do *not* plug in the power cord for the SATA drive to a switched outlet or to the AC outlet on the 8240 DVR.
- Do *not* turn off, disconnect, or unplug the SATA drive while the 8240 DVR is plugged in.

Recommendations for the SATA Drive

Contact your cable service provider for a list of approved external SATA hard disk drives. At a minimum, your SATA drive should have these capabilities:

- External SATA Connector - *SATA II: Cable and Connector, Revision 1.0* (www.sata-io.org for more information)
- Drive Speed: 7200 RPM (5400 RPM without Multi-room); 133 MB/sec
- Capacity: Only one SATA drive can be connected to the 8240 DVR. The 8240 DVR will not support a separate port multiplier.
- SATA Drive Power: The SATA drive should power on when plugged in and should not be controlled by a switch.

Connecting the 8240 DVR to an External SATA Hard Disk Drive (optional), continued

Disconnecting the External SATA Hard Disk Drive

Complete the following steps to disconnect the SATA drive safely.

1. Make sure that the 8240 DVR is powered off.
2. Disconnect the power cord from the 8240 DVR and wait for at least 10 seconds.
3. Disconnect the power cord and data cable from the external SATA drive.

If you improperly disconnect your SATA drive, you will receive an error message, and you will be required to restart the 8240 DVR upon reconnecting.

How the SATA Drive Works with Your 8240 DVR

Recordings are balanced between the internal hard drive on the 8240 DVR and the external SATA drive as follows:

- A recording is not split between an internal and external hard drive.
- The 8240 DVR automatically stores complete programs using the following space available logic:
 - If the external SATA drive has more space available, the SATA drive stores the next recording.
 - If the internal hard drive on the 8240 DVR has more space available, the internal hard drive stores the next recording.

Note: The following graphic illustrates operation logic only; it does *not* represent an actual on-screen display.

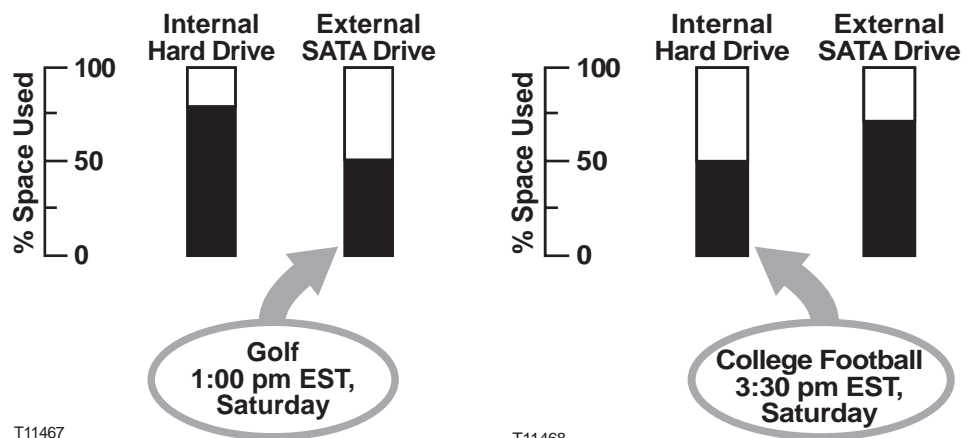

T11467

T11468

Compliance Information

United States FCC Compliance

This equipment has been tested and found to comply with the applicable limits of Part 15 of the FCC Rules. These limits are designed to provide reasonable protection against harmful interference in a residential installation. This equipment generates, uses, and can radiate radio frequency energy and, if not installed and used in accordance with the instructions, may cause harmful interference to radio or TV reception, which can be determined by turning the equipment off and on. The user is encouraged to try to correct the interference by one or more of the following measures:

- Increase the separation between the equipment and receiver
- Connect the equipment into an outlet on a circuit different from that to which the receiver is connected
- Consult your cable company or an experienced radio/TV technician for help

Any changes or modifications not expressly approved by Scientific-Atlanta could void the user's authority to operate the equipment.

Important: The information shown in the FCC Declaration of Conformity paragraph below is a requirement of the FCC and is intended to supply you with information regarding the FCC approval of this device. *The phone numbers listed are for FCC-related questions only and not intended for questions regarding the connection or operation for this device. Please contact your cable service provider for any questions you may have regarding the operation or installation of this device.*

FCC Declaration of Conformity

This device complies with *Part 15 of the FCC Rules*. Operation is subject to the following two conditions:

- 1) this device may not cause harmful interference, and
- 2) this device must accept any interference received, including interference that may cause undesired operation.

EXPLORER® 8240
Digital Home Communications Terminal:
Model 8240
Manufactured by: Scientific-Atlanta, Inc.;
5030 Sugarloaf Parkway;
Lawrenceville, Georgia 30044; USA
Telephone **770-236-1077**

Canada EMI Regulation

This Class B digital apparatus complies with Canadian ICES-003.

Cet appareil numérique de la class B est conforme à la norme NMB-003 du Canada.

Software and Firmware Use

Scientific-Atlanta, Inc. owns copyrights to the software included in your set-top and furnishes the software to your cable service provider under a license agreement. You may only use or copy this software in accordance with the terms of your cable service provider.

Scientific-Atlanta, Inc. owns copyrights to the firmware in this equipment. You may only use the firmware in the equipment in which it is provided. Any reproduction or distribution of this firmware, or any portion of it, without the express written consent of Scientific-Atlanta, Inc. is prohibited.

Trademarks

Explorer, Scientific-Atlanta, and the Scientific-Atlanta logo are registered trademarks of Scientific-Atlanta, Inc. 8240 is a trademark of Scientific-Atlanta, Inc. All other trademarks shown are trademarks of their respective owners.

Disclaimer

Scientific-Atlanta, Inc. assumes no responsibility for errors or omissions that may appear in this guide. Scientific-Atlanta reserves the right to change this guide at any time without notice.



© 2005 by Scientific-Atlanta, Inc. All rights reserved.

Product and service availability subject to change without notice.

Scientific-Atlanta, Inc., 5030 Sugarloaf Parkway, P.O. Box 465447, Lawrenceville, GA 30042

www.scientificatlanta.com

April 2005 Printed in the United States of America

4010318 Rev A